



VPI Transformer (ClassH/C)

DuPont Nomex Insulation System

SAFE, RELIABLE, ENVIRONMENTAL FRIENDLY





Founded in 1990, CEEG has been focusing on manufacturing for 30 years and exporting quality power equipment to the world with the core values of "Vision, Innovation and Responsibility". So far, CEEG has three major industries: power transmission and distribution, new energy and system solutions, with industrial bases in Nanjing and Yangzhong.

CEEG was successively awarded the honorary titles of National Innovative Enterprise, Top 500 Asian Brands, Most Influential Brand of China Electrical Industry, China Environmental Label, and National Contract-observing and Creditable Enterprise. In 2011, CEEG was ranked 183rd among the top 500 private enterprises in China with sales of 10.9 billion.

China Electric Equipment (Jiangsu) Transformer Manufacture Co., Ltd. is a modern enterprise integrating manufacturing, sales and scientific research. It has a complete set of shearing machines, automatic wrapping machine, robotic automatic laminating machine, German Hedrich vacuum casting tank, vacuum impregnation, electric transfer vehicle and other advanced equipments representing a high level in the industry, and is the first in the industry to develop and apply transformer collaborative design platform to effectively combine product data, product development and production process. CEEG's products include VPI transformer, cast resin transformer, semi-en-

velope transformer, oil-immersed transformers, traction transformers, 220kV power transformers, 110kV power transformer, mining explosion-proof transformer, mining explosion-proof switches, high and low voltage switchgear, frequency conversion transformer, amorphous alloy transformer, anti-harmonic transformer, Scott transformer, substation, wind power transformer, marine transformer, etc. Its sales cover many industries such as electric power, electronics, hydropower, nuclear power, wind power, coal mines, communications, construction, petroleum, chemical industry, aviation, transportation, railroad, etc.

Walking with giants and keeping pace with the world, CEEG has established long-term strategic partnerships with world-class companies such as DuPont, Schneider, DSL. Pursuing innovation, fulfilling responsibilities, and constantly surpassing products, quality, services and actions, it has developed into a domestic giant power transmission and distribution equipment supplier with a solid industrial foundation. Its cast resin dry type transformers have been exported to more than 40 countries and regions in the world. The strategic layout of brand internationalization and service globalization has been formed!

Make CEEG the world's first choice!

CEEG & DuPont

- + In 1999, CEEG established a strategic partnership with DuPont and became a licensed manufacturer of DuPont ReliatraN.
- + In 2000, SG10 VPI dry-type transformer was successfully developed by CEEG and passed the national appraisal.
- + In 2001, CEEG established Jiangsu CEEG Transformer Manufacturing Co., Ltd., specializing in the production of SG (B) series VPI transformers.
- + In 2005, the annual sales of SG (B) series transformer products reached 450 million yuan.
- + In 2009, SG (B) series transformer products sold more than 20,000 sets, and the company has become the world's largest VPI transformer manufacturing base.
- + In 2012, CEEG deepened cooperation with DuPont to further increase its support for CEEG SG (B) series transformer products.
- + Following the signing of the DuPont Nomex brand trademark licensing agreement in 2010, the only national licensing agreement for DuPont Nomex insulation system and the "ReliatraN" brand licensing agreement were signed.



CEEG products bring you...	02
VPI Transformer VS Cast Resin Transformer	03
Design, Equipments and Manufacturing process	04
Technical Parameter	06
Solution: overload solution	22
Solution: environmental protection solution	23
Solution: protection solution	24
Special purpose transformer	25
Qualifications & Honors	29
Industry Standards	30
Certificate	31
Product Family	32

CEEG products bring you...



+ High Security

VPI transformer has no combustible resin, halogen-free, and non-combustion supporting and flame retardant in use. It will not explode and release toxic gases, will not cause harm to the environment, other equipment and human body, and is insensitive to temperature, dust and pollution; The operation partial discharge is small and will never crack. Its safety characteristics are especially suitable for places with high fire protection requirements and high population density.



+ High Reliability

The high and low voltage coils are made of Nomex Paper insulation material, impregnated with H-grade solvent-free impregnation paint several times by VPI vacuum pressurization equipment, and baked and cured at high temperature several times. The product is class H (180 °C), and the main insulating material is class C (220 °C), with a large overload margin and good short-circuit resistance. It is allowed to overload 20% for long-term operation without fan. The products are especially suitable for places requiring high power supply reliability, such as factories, mines, medical treatment, data centers and scientific research institutions.



+ Energy saving and environmental protection

After the end of product life, copper, iron and other materials are easy to recycle; The insulating material Nomex Paper will not release toxic substances when burning; Other insulating materials can degrade without polluting the environment; Low loss and energy saving;



+ Quality Assurance

Through VPI vacuum dipping technology, the body is repeatedly dipped and cured at high temperature, which greatly enhances the insulation strength and reduces partial discharge. In addition, with good heat dissipation structure design and high-quality insulating materials, the design service life is up to 30 years, long-term maintenance free operation can be realized, and a warranty period of up to 4 years is promised.



+ Flexible Design

VPI transformer does not need molds for production, and the design is flexible. Personalized design can be carried out according to customer requirements and on-site conditions, with short production and manufacturing cycle and timely supply.

VPI Transformer VS Cast Resin Transformer

Product Category	Cast Resin Transformer	VPI Transformer
Product Model	SC(B)10 or SC(B)11	SG(B)10 or SG(B)11
Thermal Insulation Grade	F (155 °C) or H (180 °C)	H (180 °C) or C (220 °C)
Reference Standard	GB1094.11-2007 GB/T10228-2015	GB1094.11-2007 GB/T10228-2015 HD464、UL NFC52
Main Insulating Materials	Epoxy Resin	DuPont Nomex
Environmental Safety	It is not environmentally friendly and has some flame retardancy. Passed the F1 combustion test	Environmental protection, high safety, no toxic gases, flame retardant. Passed the F1 combustion test
Thermal Shock Resistance	Strong	Strong, Suitable for condensation, salt spray, humidity and other harsh environments, Passed the E2 environmental test
Moisture Resistance	Strong	Strong
Coil Structure	The LV is cylindrical or foil type the HV is layer type	The LV is a foil type the HV is a continuous type
Manufacturing Process Characteristics	Vacuum pouring, high process requirements Molds are required	Nomex and binder are cured at high temperature The coil is produced in the normal winding process VPI vacuum pressure impregnation technology, flexible design, no restriction by molds and short processing time
Mechanical Properties	Epoxy resin is cured after casting and has good mechanical strength, but cracking may occur. The dielectric constant of epoxy resin is large, the electric field is non-uniform, and it is very sensitive to bubbles. Under mature process conditions, the partial discharge can be less than 5pc.	Nomex has good mechanical strength and higher strength after curing, never cracks Nomex has high electrical strength, small dielectric constant, uniform electric field, reasonable insulation system design and stable performance. Adopting mature American technology, the partial discharge can be less than 5pc.
After Service Life	Recycling costs are high and cause pollution.	The recycle cost is low and no environmental pollution
Mold	Yes (customized)	None (flexible design)
Noise	Better than national standard	Better than national standard
Heat Dissipation Performance	Ordinary	Heat dissipation capacity is very high the fan is not required for normal operation
Overload Capacity	Strong	Very strong (overload 20% - 50% in air-cooled condition)

+ Compared to ordinary cast resin dry-type transformers, the SG (B) series of VPI dry-type transformers offers obvious advantages in terms of safety, reliability and environmental protection. Choose one of these two transformers according to your specific requirements.

Design, Equipments and Manufacturing process

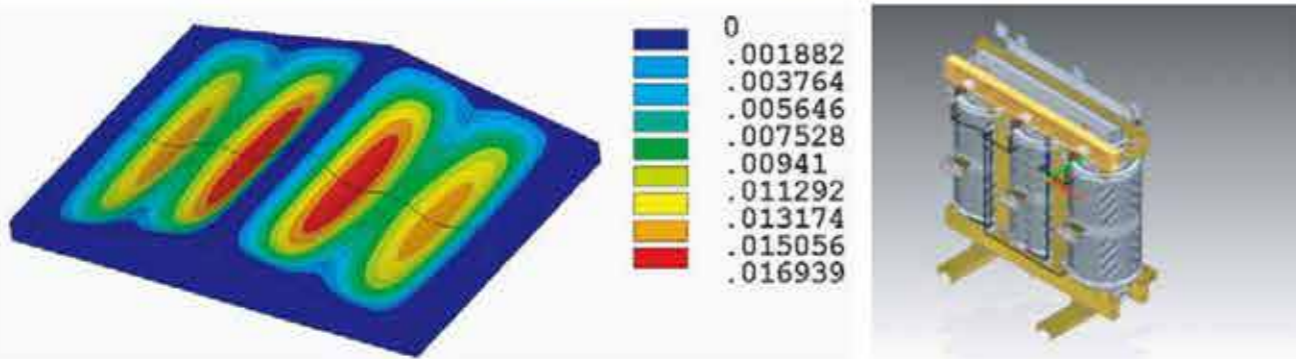

+ Design

CEEG has integrated more than 20 years of design, manufacturing and experiment experience in various transformer factories of the group and developed a series of advanced "three-dimensional + parametric" design software, which can realize automatic design and cost optimization, simulation and simulation. The requirements of national and industrial standards are fully considered to ensure advanced design of products.



+ Semi Finished High Voltage Coil

The high voltage coil has a continuous structure with high mechanical strength and good heat dissipation conditions, which avoids the disadvantages of high voltage between layers, poor heat dissipation, easy thermal breakdown and low mechanical strength of the multilayer coil. It will never crack and the partial discharge is less than 5pC, which improves the reliability of the product.



+ Semi Finished Low Voltage Coil

The low voltage coil consists of a foil or a longitudinally oriented high current spiral (national patent No: 002219069) impregnated by VPI vacuum pressure into a solid whole having high short circuit, shock, moisture, dust and salt fog resistance.



+ Iron Core

The iron core is made of high quality, highly magnetically conductive, oriented silicon steel sheet with 45° full oblique step lapping process. The surface is coated with a special moisture and rust resistant coating, which effectively reduces the no-load loss, no-load current and noise level.



+ Advanced Testing Equipments

Before delivery, rigorous testing and inspection are carried out in accordance with the requirements of national standards GB6450-1986 and JB / t501-xxxx. Partial discharge test, lightning protection test, electric shock test and noise test are considered as necessary test points. Advanced testing equipments and perfect testing system ensure the high quality and high quality standard of products.

Technical Parameter

Model description of SG (B) 10 series distribution transformer

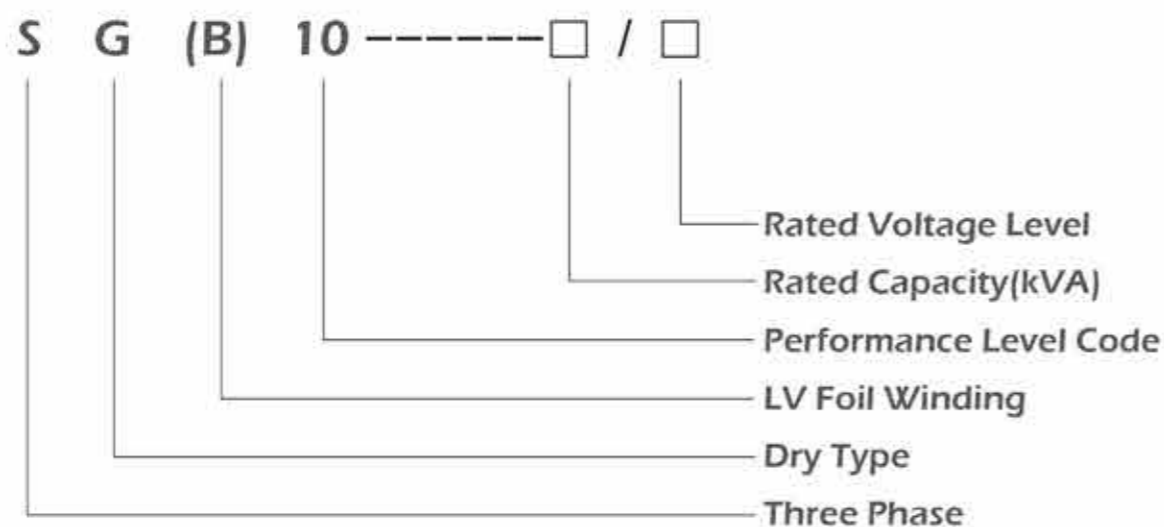

CEEG's main models of SG (B) series are SG (B) 10, SG (B) 11, SGZB, SGRB, SCRB, etc. The product voltages are mainly 6kV, 10kV, 20kv-10kv, 35kV, etc.

Accessories

+ Enclosure



The enclosure can be divided into indoor type and outdoor type. There are several observation windows on the enclosure, and the enclosure can be sprayed with the color of the user's choice.

The degree of protection of the enclosure is generally divided into IP20 or IP23. IP20 prevents the ingress of solid foreign objects larger than 12 mm and protects against accidental shocks. In addition to the functions of IP20, IP23 can also prevent water drops from entering within 60 degrees from the vertical, which is suitable for outdoor installation.

The material of the enclosure is divided into: ordinary steel sheet, plastic injection molding, stainless steel sheet, aluminum alloy composite sheet, etc.

+ Temperature Controller



All transformers are equipped with an overheating protection device. The overheat protection device detects and controls the temperature of the transformer by means of a PT thermistor built into the low voltage coil and outputs a digital signal via the RS232 / 485 communication interface. The device provides the following functions:

1. during the operation of the transformer, the temperature value of the three-phase winding is displayed on a circuit.
2. display of the temperature value of the hottest phase winding.
3. overtemperature alarm and overtemperature shutdown.
4. audible and visual alarm and fan start.

+ Air Cooling Device



The cooling mode of dry-type transformer is divided into natural air cooling (AN) and forced air cooling (AF).

Natural air cooling (AN) can continuously provide 120% of the rated power under normal operating conditions.

Forced air cooling (AF) can increase the capacity by 50% under normal operating conditions, which is suitable for all types of emergency overloads or intermittent overload operation. Due to the large increase in load losses and impedance resistance, forced air cooling (AF) is generally not recommended for long-term continuous overload operation.

+ Copper Bar



1. in general, the incoming and outgoing modes of the cables are divided into: upper incoming & outgoing, lower incoming & outgoing, side incoming & outgoing.

2. for transformer with rated power < 200KVA, the conventional outgoing mode is still used, and the side outgoing line is connected by the user with a cable.

3. if the rated power is > 1600KVA, a, b, and c use double-row feeder lines with a spacing of 10 (1600200kva) or 12 (2500kVA).

4. since the zero line is at the top of the transformer, it is recommended that the transformer zero line still enters the switchgear from the top if the zero line is brought out from the bottom of the switchgear.

Technical Parameter

SG(B)10-100~3150/10

HV: 10 (10.5, 11, 6.6, 6.3, 6)kV
LV: 0.4kV

Vector Group: Dyn11, Yyn0
Tapping Range: $\pm 2 \times 2.5\%$

Model	Uk %	P0 (W)	Pk (75°) (W)	I0%	LPA(AN)dB	L×B×H(mm)	m x n (mm)	Enclosure Size (top outgoing line) (footing included)	Enclosure Size (side outgoing line) (footing included)
SG(B)10-100/10	4%	400	1370	0.7	42	930×750×840	550×550	1700×1400×1600	1700×1400×2200
SG(B)10-125/10	4%	470	1610	0.7	43	930×750×840	550×550	1700×1400×1600	1700×1400×2200
SG(B)10-160/10	4%	540	1860	0.7	43	1010×750×880	550×550	1700×1400×1600	1700×1400×2200
SG(B)10-200/10	4%	620	2210	0.7	43	1010×750×880	550×550	1700×1400×1600	1700×1400×2200
SG(B)10-250/10	4%	720	2410	0.7	43	1050×860×890	660×660	1700×1400×1600	1700×1400×2200
SG(B)10-315/10	4%	880	3040	0.7	45	1100×860×980	660×660	1700×1400×1600	1700×1400×2200
SG(B)10-400/10	4%	980	3490	0.7	45	1130×860×1000	660×660	1700×1400×1600	1700×1400×2200
SG(B)10-500/10	4%	1160	4270	0.6	46	1200×860×1030	660×660	1700×1400×1600	1700×1400×2200
SG(B)10-630/10	4%	1340	5130	0.6	46	1280×860×1100	820×660	1900×1500×1800	1900×1500×2200
SG(B)10-630/10	6%	1300	5220	0.6	46	1350×860×1000	820×660	1900×1500×1800	1900×1500×2200
SG(B)10-800/10	6%	1520	6080	0.4	49	1400×1020×1040	820×820	1900×1500×1800	1900×1500×2200
SG(B)10-1000/10	6%	1770	7140	0.4	50	1410×1020×1050	820×820	1900×1500×1800	1900×1500×2200
SG(B)10-1250/10	6%	2090	8400	0.4	51	1460×1020×1140	820×820	2000×1600×2000	2000×1600×2200
SG(B)10-1600/10	6%	2450	10190	0.3	51	1470×1150×1270	1070×1070	2000×1600×2000	2000×1600×2200
SG(B)10-2000/10	6%	3050	12640	0.3	52	1600×1150×1370	1070×1070	2200×1600×2200	2200×1600×2200
SG(B)10-2500/10	6%	3600	15000	0.3	53	1610×1150×1490	1070×1070	2200×1600×2200	2200×1600×2200
SG(B)10-3150/10	6%	5040	18190	0.3	56	1700×1150×1490	1070×1070	2200×1600×2200	2200×1600×2200

Note: The data given in this manual is for planning and selection purposes only. Final data may vary.

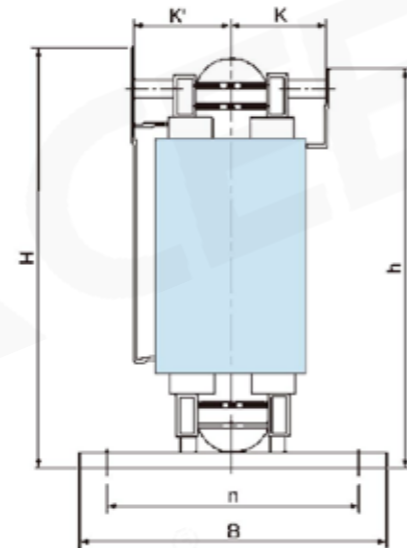
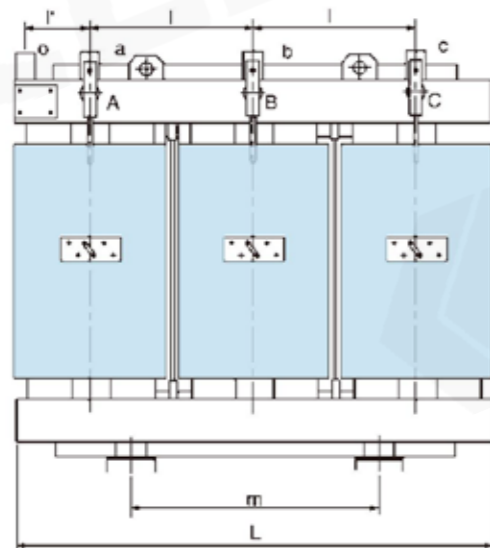

LV terminal bus

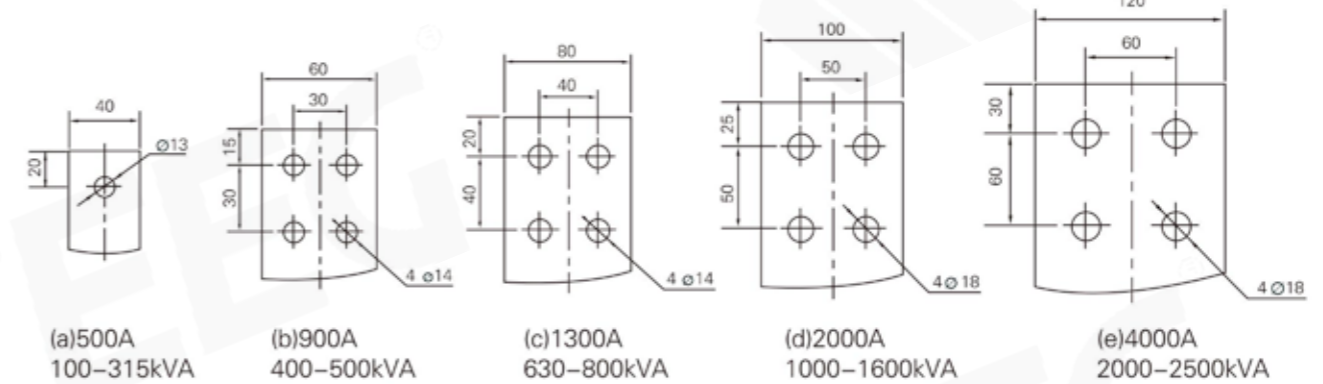

Technical Parameter

SG(B)12-100~2500/10

HV: 10 (10.5, 11, 6.6, 6.3, 6)kV
LV: 0.4kV

Vector Group: Dyn11, Yyn0
Tapping Range: $\pm 2 \times 2.5\%$

Model	Uk %	P0 (W)	Pk (75°) (W)	I0%	LPA(AN)dB	L×B×H(mm)	m x n (mm)	Enclosure Size (top outgoing line) (footing included)	Enclosure Size (side outgoing line) (footing included)
SG(B)12-100/10	4	320	1370	0.7	42	900×750×880	550×550	1700×1400×1600	1700×1400×2200
SG(B)12-125/10	4	375	1610	0.7	43	900×750×880	550×550	1700×1400×1600	1700×1400×2200
SG(B)12-160/10	4	430	1860	0.7	43	970×750×940	550×550	1700×1400×1600	1700×1400×2200
SG(B)12-200/10	4	495	2210	0.7	43	970×750×940	550×550	1700×1400×1600	1700×1400×2200
SG(B)12-250/10	4	575	2410	0.7	43	1000×860×950	660×660	1700×1400×1600	1700×1400×2200
SG(B)12-315/10	4	705	3040	0.7	45	1080×860×1040	660×660	1700×1400×1600	1700×1400×2200
SG(B)12-400/10	4	785	3490	0.7	45	1100×860×1060	660×660	1700×1400×1600	1700×1400×2200
SG(B)12-500/10	4	930	4270	0.6	46	1170×860×1070	660×660	1700×1400×1600	1700×1400×2200
SG(B)12-630/10	4	1070	5130	0.6	46	1260×860×1120	820×660	1900×1500×1800	1900×1500×2200
SG(B)12-630/10	6	1040	5220	0.6	46	1330×860×1040	820×660	1900×1500×1800	1900×1500×2200
SG(B)12-800/10	6	1215	6080	0.4	49	1370×1020×1120	820×820	1900×1500×1800	1900×1500×2200
SG(B)12-1000/10	6	1415	7140	0.4	50	1390×1020×1190	820×820	1900×1500×1800	1900×1500×2200
SG(B)12-1250/10	6	1670	8400	0.4	51	1410×1020×1280	820×820	2000×1600×2000	2000×1600×2200
SG(B)12-1600/10	6	1960	10190	0.3	51	1410×1150×1480	1070×1070	2000×1600×2000	2000×1600×2200
SG(B)12-2000/10	6	2440	12640	0.3	52	1420×1150×1500	1070×1070	2200×1600×2200	2200×1600×2200
SG(B)12-2500/10	6	2880	15000	0.3	53	1510×1150×1590	1070×1070	2200×1600×2200	2200×1600×2200

Note: The data given in this manual is for planning and selection purposes only. Final data may vary.

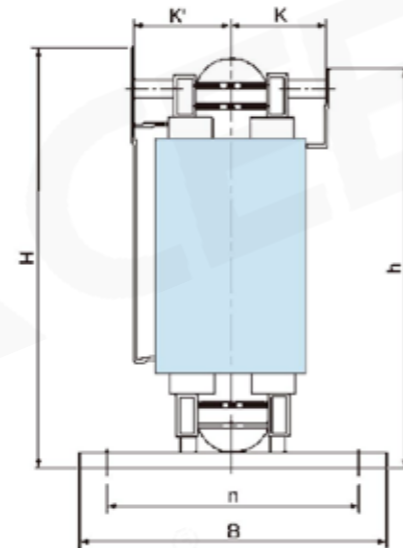
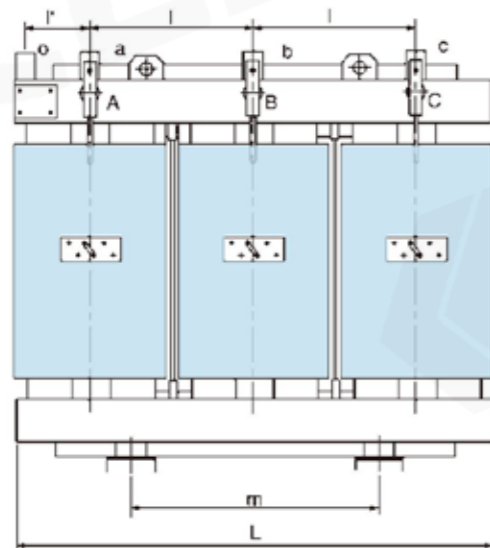

LV terminal bus

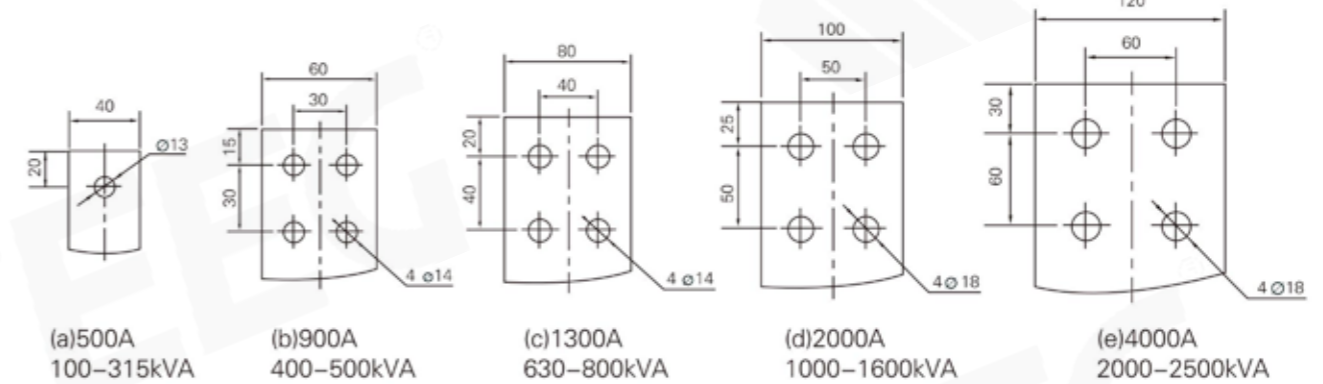

Technical Parameter

SG(B)13-100~2500/10

HV: 10 (10.5,11,6.6,6.3,6)kV
LV: 0.4kV

Vector Group: Dyn11, Yyn0
Tapping Range: $\pm 2 \times 2.5\%$

Model	Uk %	P0 (W)	Pk (75°) (W)	I0%	LPA(AN)dB	L×B×H(mm)	m x n (mm)	Enclosure Size (top outgoing line) (footing included)	Enclosure Size (side outgoing line) (footing included)
SG(B)13-100/10	4	290	1230	0.7	42	980×750×840	550×550	1700×1400×1600	1700×1400×2200
SG(B)13-125/10	4	340	1450	0.7	43	980×750×840	550×550	1700×1400×1600	1700×1400×2200
SG(B)13-160/10	4	390	1670	0.7	43	1050×750×890	550×550	1700×1400×1600	1700×1400×2200
SG(B)13-200/10	4	450	1990	0.7	43	1070×750×890	550×550	1700×1400×1600	1700×1400×2200
SG(B)13-250/10	4	520	2170	0.7	43	1090×860×940	660×660	1700×1400×1600	1700×1400×2200
SG(B)13-315/10	4	630	2740	0.7	45	1120×860×1030	660×660	1700×1400×1600	1700×1400×2200
SG(B)13-400/10	4	710	3140	0.7	45	1140×860×1050	660×660	1700×1400×1600	1700×1400×2200
SG(B)13-500/10	4	840	3840	0.6	46	1230×860×1060	660×660	1700×1400×1600	1700×1400×2200
SG(B)13-630/10	4	960	4620	0.6	46	1300×860×1080	820×660	1900×1500×1800	1900×1500×2200
SG(B)13-630/10	6	940	4700	0.6	46	1360×860×1050	820×660	1900×1500×1800	1900×1500×2200
SG(B)13-800/10	6	1090	5470	0.4	49	1420×1020×1130	820×820	1900×1500×1800	1900×1500×2200
SG(B)13-1000/10	6	1270	6430	0.4	50	1420×1020×1200	820×820	1900×1500×1800	1900×1500×2200
SG(B)13-1250/10	6	1500	7560	0.4	51	1420×1020×1290	820×820	2000×1600×2000	2000×1600×2200
SG(B)13-1600/10	6	1760	9170	0.3	51	1520×1150×1390	1070×1070	2000×1600×2000	2000×1600×2200
SG(B)13-2000/10	6	2200	11380	0.3	52	1550×1150×1460	1070×1070	2200×1600×2200	2200×1600×2200
SG(B)13-2500/10	6	2590	13500	0.3	53	1570×1150×1580	1070×1070	2200×1600×2200	2200×1600×2200

Note: The data given in this manual is for planning and selection purposes only. Final data may vary.

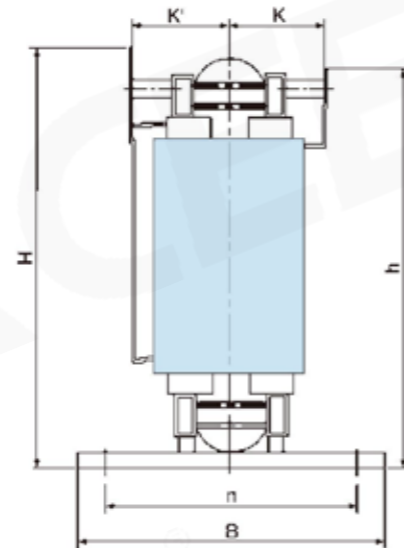
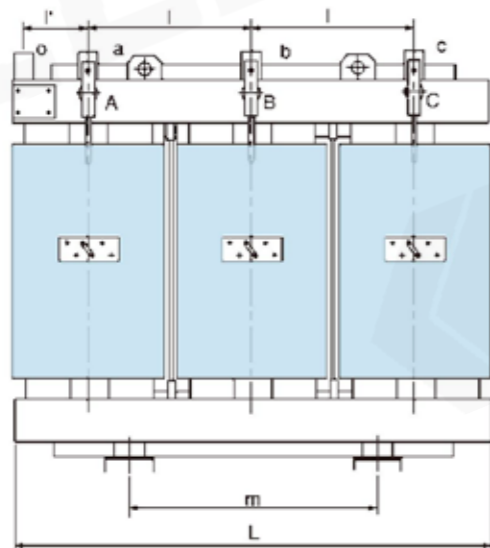

LV terminal bus

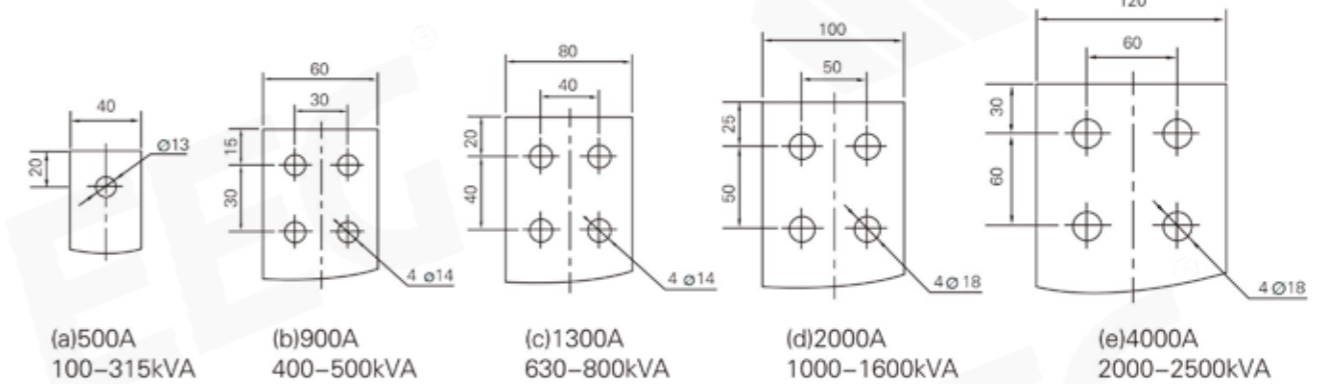

Technical Parameter

SG(B)14-100~2500/10

HV: 10 (10.5,11,6.6,6.3,6)kV
LV: 0.4kV

Vector Group: Dyn11, Yyn0
Tapping Range: $\pm 2 \times 2.5\%$

Model	Uk %	P0 (W)	Pk (75°) (W)	I0%	LPA(AN)dB	L×B×H(mm)	m x n (mm)	Enclosure Size (top outgoing line) (footing included)	Enclosure Size (side outgoing line) (footing included)
SG(B)14-100/10	4	270	1240	0.7	42	980×750×840	550×550	1700×1400×1600	1700×1400×2200
SG(B)14-125/10	4	320	1450	0.7	42	980×750×840	550×550	1700×1400×1600	1700×1400×2200
SG(B)14-160/10	4	360	1670	0.7	42	1050×750×890	550×550	1700×1400×1600	1700×1400×2200
SG(B)14-200/10	4	420	1990	0.7	43	1070×750×890	550×550	1700×1400×1600	1700×1400×2200
SG(B)14-250/10	4	490	2170	0.7	43	1090×860×940	660×660	1700×1400×1600	1700×1400×2200
SG(B)14-315/10	4	600	2730	0.7	45	1120×860×1030	660×660	1700×1400×1600	1700×1400×2200
SG(B)14-400/10	4	660	3140	0.7	45	1140×860×1050	660×660	1700×1400×1600	1700×1400×2200
SG(B)14-500/10	4	790	3830	0.6	46	1230×860×1060	660×660	1700×1400×1600	1700×1400×2200
SG(B)14-630/10	4	910	4610	0.6	46	1300×860×1080	820×660	1900×1500×1800	1900×1500×2200
SG(B)14-630/10	6	880	4690	0.6	46	1360×860×1050	820×660	1900×1500×1800	1900×1500×2200
SG(B)14-800/10	6	1030	5470	0.4	49	1420×1020×1130	820×820	1900×1500×1800	1900×1500×2200
SG(B)14-1000/10	6	1200	6430	0.4	50	1420×1020×1200	820×820	1900×1500×1800	1900×1500×2200
SG(B)14-1250/10	6	1420	7610	0.4	51	1420×1020×1290	820×820	2000×1600×2000	2000×1600×2200
SG(B)14-1600/10	6	1660	9230	0.3	51	1520×1150×1390	1070×1070	2000×1600×2000	2000×1600×2200
SG(B)14-2000/10	6	2070	11420	0.3	52	1550×1150×1460	1070×1070	2200×1600×2200	2200×1600×2200
SG(B)14-2500/10	6	2450	13540	0.3	53	1570×1150×1580	1070×1070	2200×1600×2200	2200×1600×2200

Note: The data given in this manual is for planning and selection purposes only. Final data may vary.

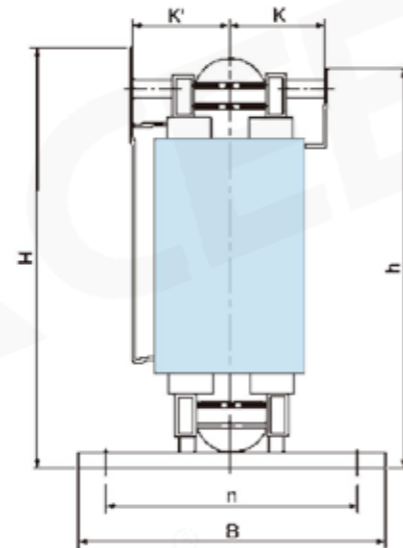
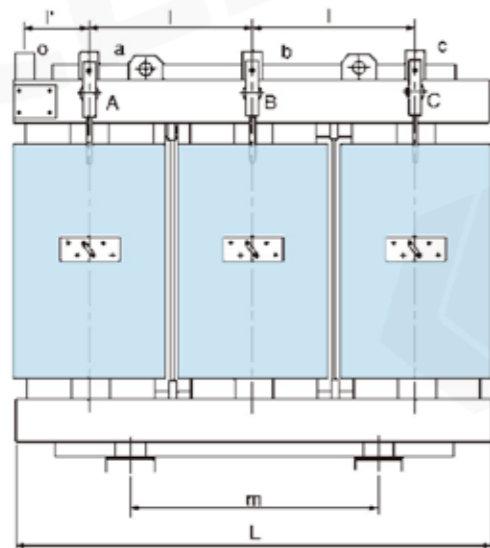

LV terminal bus

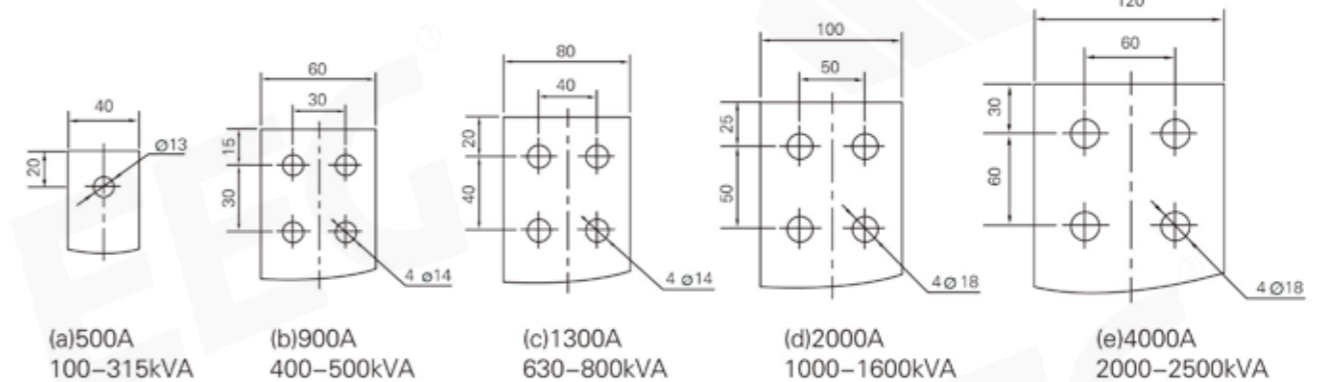

Technical Parameter

SG(B)18-100~2500/10

HV: 10 (10.5, 11, 6.6, 6.3, 6)kV
LV: 0.4kV

Vector Group: Dyn11, Yyn0
Tapping Range: $\pm 2 \times 2.5\%$

Model	Uk %	P0 (W)	Pk (75°) (W)	I0%	LPA(AN)dB	L×B×H(mm)	m x n (mm)	Enclosure Size (top outgoing line) (footing included)	Enclosure Size (side outgoing line) (footing included)
SG(B)18-100/10	4	230	1240	0.7	42	980×750×840	550×550	1700×1400×1600	1700×1400×2200
SG(B)18-125/10	4	270	1450	0.7	42	980×750×840	550×550	1700×1400×1600	1700×1400×2200
SG(B)18-160/10	4	310	1670	0.7	42	1050×750×890	550×550	1700×1400×1600	1700×1400×2200
SG(B)18-200/10	4	360	1990	0.7	43	1070×750×890	550×550	1700×1400×1600	1700×1400×2200
SG(B)18-250/10	4	420	2170	0.7	43	1090×860×940	660×660	1700×1400×1600	1700×1400×2200
SG(B)18-315/10	4	510	2730	0.7	45	1120×860×1030	660×660	1700×1400×1600	1700×1400×2200
SG(B)18-400/10	4	560	3140	0.7	45	1140×860×1050	660×660	1700×1400×1600	1700×1400×2200
SG(B)18-500/10	4	670	3830	0.6	46	1230×860×1060	660×660	1700×1400×1600	1700×1400×2200
SG(B)18-630/10	4	770	4610	0.6	46	1300×860×1080	820×660	1900×1500×1800	1900×1500×2200
SG(B)18-630/10	6	750	4690	0.6	46	1360×860×1050	820×660	1900×1500×1800	1900×1500×2200
SG(B)18-800/10	6	880	5470	0.4	49	1420×1020×1130	820×820	1900×1500×1800	1900×1500×2200
SG(B)18-1000/10	6	1020	6430	0.4	50	1420×1020×1200	820×820	1900×1500×1800	1900×1500×2200
SG(B)18-1250/10	6	1210	7610	0.4	51	1420×1020×1290	820×820	2000×1600×2000	2000×1600×2200
SG(B)18-1600/10	6	1410	9230	0.3	51	1520×1150×1390	1070×1070	2000×1600×2000	2000×1600×2200
SG(B)18-2000/10	6	1760	11420	0.3	52	1550×1150×1460	1070×1070	2200×1600×2200	2200×1600×2200
SG(B)18-2500/10	6	2080	13540	0.3	53	1570×1150×1580	1070×1070	2200×1600×2200	2200×1600×2200

Note: The data given in this manual is for planning and selection purposes only. Final data may vary.

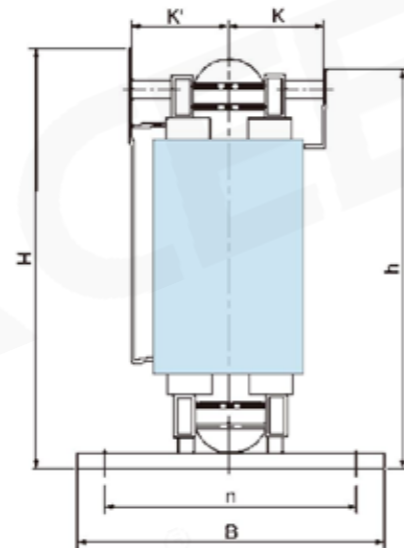
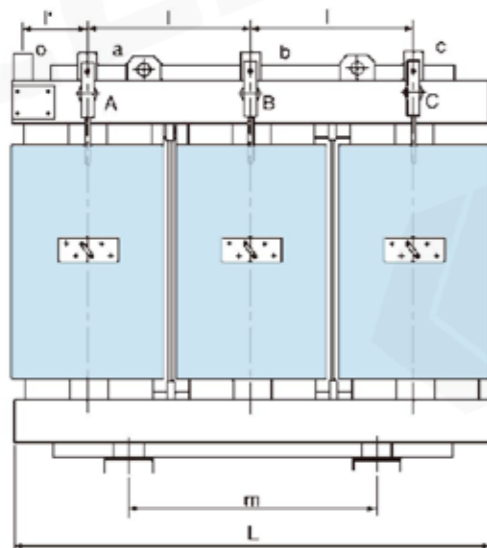

LV terminal bus

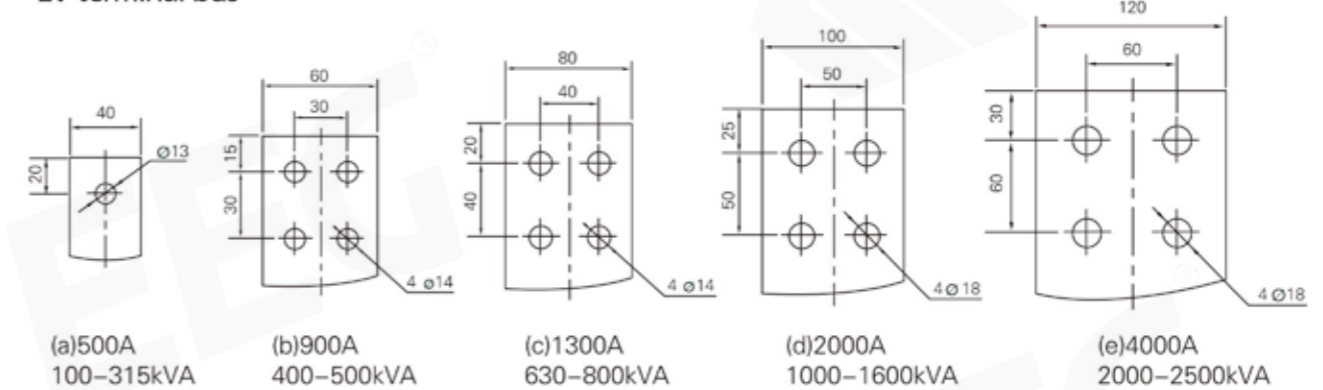

Technical Parameter

10kV SGZ(B)10

HV: 10kV, 6kV Vector Group: Dyn11, Yyn0
 LV: 0.4kV Tapping Range: $\pm 2 \times 2.5\%$, $\pm 5\%$, etc

Model	Uk %	P0 (W)	Pk (145°) (W)	IO %	LPA(AN)dB	Transformer Size LxBxH(mm)	m x n (mm)	Transformer Weight (kg)	Enclosure Size LxBxH(mm)	Enclosure Weight (kg)
SGZB-250/10	4	720	2400	0.8	46	1260×860×1115	660×660	1400	1700×1240×1610	220
SGZB-315/10	4	880	3730	0.7	46	1260×860×1150	660×660	1450	1700×1240×1610	220
SGZB-400/10	4	980	4280	0.7	46	1360×860×1318	660×660	1965	1800×1240×1660	240
SGZB-500/10	4	1180	5230	0.6	48	1355×860×1365	660×660	2145	1800×1240×1760	260
SGZB-630/10	4	1340	6290	0.5	49	1355×860×1405	820×660	2320	1900×1340×1865	280
SGZB-630/10	6	1300	6400	0.5	50	1430×860×1405	820×660	2205	1900×1340×1865	280
SGZB-800/10	6	1520	7480	0.4	51	1475×1020×1467	820×820	2635	2000×1380×1865	320
SGZB-1000/10	6	1770	8760	0.4	51	1495×1020×1537	820×820	2720	2000×1380×1965	340
SGZB-1250/10	6	2090	10300	0.3	52	1550×1020×1612	820×820	3225	2100×1380×1965	350
SGZB-1600/10	6	2450	12500	0.3	53	1655×1150×1772	1070×1070	4115	2200×1410×2270	400
SGZB-2000/10	6	3050	15500	0.25	53	1655×1270×1932	1070×1070	4365	2200×1450×2270	440
SGZB-2500/10	6	3600	18400	0.25	54	1685×1270×2070	1070×1070	5450	2300×1450×2370	480

Note: The data given in this manual is for planning and selection purposes only. Final data may vary.

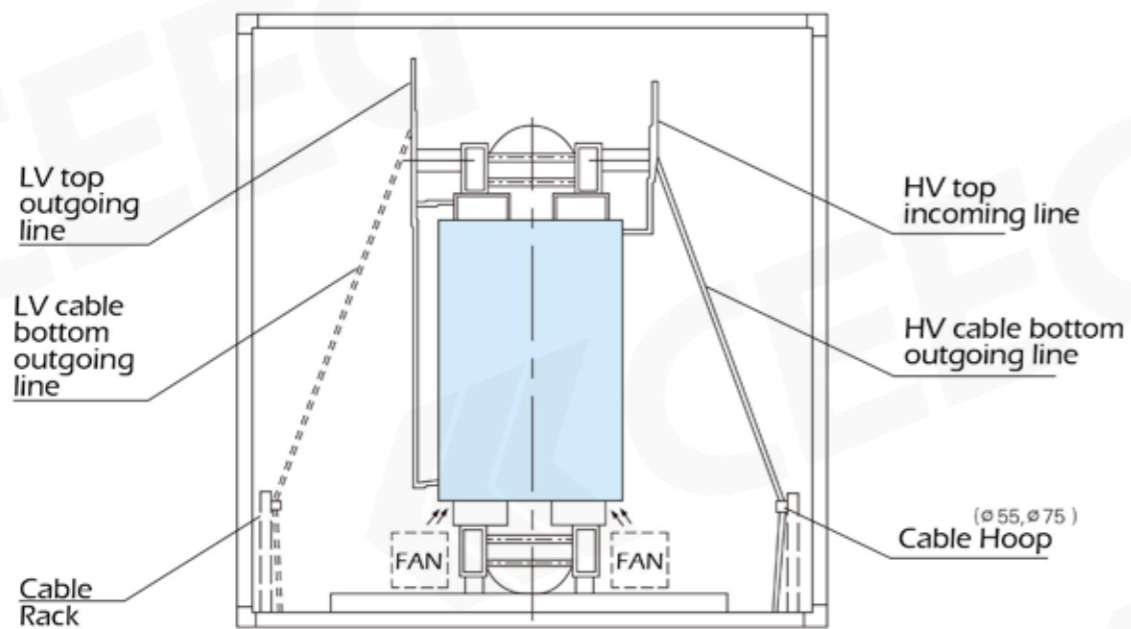

Note:
 For transformers with capacity $\leq 500\text{kVA}$, the base channel steel is 14# H1 = 60;
 For transformers with capacity of 630kVA ~ 1250kva, the base channel steel is 16# i.e. H1 = 65;
 For transformers with capacity $\geq 1000\text{kVA}$, the base channel steel is 18# H1 = 70.

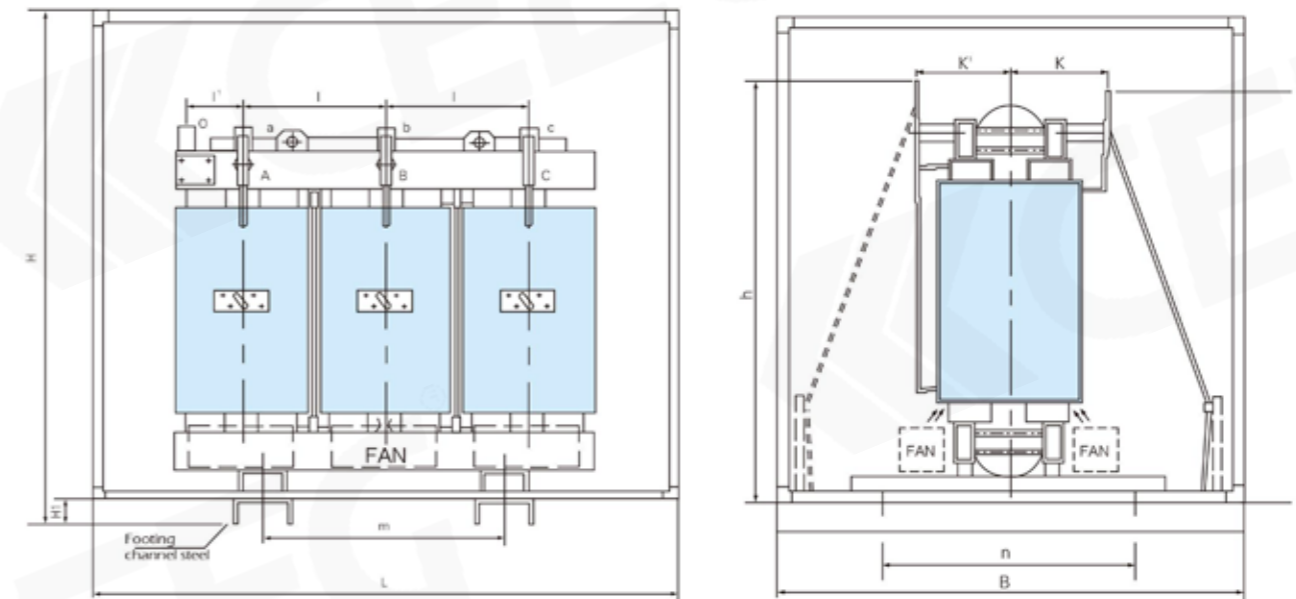

The beautiful and robust stainless steel enclosure provides further safety protection for the transformer, with IP20, IP23 and IP42 protection levels.

- * IP20 enclosure can prevent the ingress of solid foreign objects greater than 12mm in diameter and provides a safety barrier for live parts.
- * IP23 also prevents the ingress of water droplets within 60 degrees of vertical and is suitable for outdoor use.
- * IP42 can prevent ingress of foreign objects greater than 1mm in diameter and can still prevent ingress of water droplets when the unit is tilted 15 degrees; when the unit is tilted 15 degrees from vertical, dripping water will not cause damage to the unit.

The IP23 enclosure reduces the cooling capacity of the transformer by approximately 5% for smaller capacities and 10% for larger capacities.

Solution: Overload Solution

(1) Operating conditions of national standard GB6450-1986:

- Ambient temperature: maximum temperature + 40 °C.
- Maximum daily average temperature + 30 °C.
- Maximum annual average temperature + 20 °C
- Minimum temperature: - 30 °C (outdoor), - 5 °C (indoor)

(2) Horizontal axis - product load; longitudinal axis - average temperature rise of product coil K. (note that the temperature is not °C);

(3) For class H insulation products, the long-term withstand temperature of the insulation material is specified as 180 °C by the state, while the insulation material Nomex Paper used by CEEG to produce SG (B) series transformer products is class C (220 °C), and the

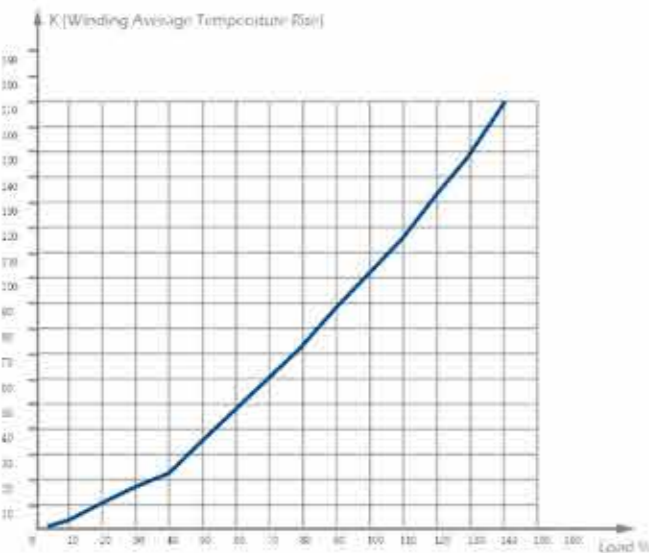

insulation paint is class H (180 °C) or class C (220 °C), which provides a wide margin for the overload of the product.

(4) For example:

A. When the transformer operates at 70% load, the average temperature rise of the coil is 57K. When the ambient temperature is 25 °C, the average coil temperature $T = \text{coil temperature rise} + \text{ambient temperature} = 57 + 25 = 82 °C$.

b. When the transformer is operated at 120% load and the ambient temperature is 40 °C, the average coil temperature is $t = 133 + 40 = 173 < 200 °C$; local coil hot spot temperature = $173 \times 1.07 = 185 °C$.

Note: 120% load of SG (B) series transformer products is achieved without fan. If fan is configured, the short-time overload capacity can reach more than 50%. We do not recommend long-term overload operation of the product, which only shows that the SG10 product has sufficient capacity to provide more load in case of emergency. Secondly, it also shows that the service life of the product under rated load is long enough, which also reduces the investment cost in the long run.

Using Class C (220 °C) insulating materials to make Class H (180 °C) products is far better than the old epoxy products (Class F products are made with Class F (155 °C) materials with no overload margin).

The large overload margin can resist the effects of a large electric field and ensure the stability of the power supply. This is absolutely reliable equipment for places with unstable electric fields, industries with high overload requirements, and industries with high power supply stability requirements, such as glass industry, steel industry, automobile manufacturing, commercial construction, microelectronics industry, cement industry, water treatment and pumping stations, petrochemical industry hospitals, data centers, etc.



Solution: Environmental Protection Solution

Producing more energy efficient and environmentally friendly products is the constant goal of CEEG. Based on this goal, the current SG (B) series products have the following features:

- + **(1) The insulation system based on Nomex paper has high safety performance:**
 - A. Nomex paper products do not cause toxic reactions to humans and animals;
 - B. Nomex paper is flame retardant and does not support combustion. At 220 °C, the LOI > 20.8% (more than the oxygen content in normal air), so it will extinguish automatically after the external fire source is removed;
 - C. Nomex paper does not contain halogen. During combustion, the smoke concentration is low and no toxic gases are released;

Nomex paper has passed the world's most significant UL safety certification.
- + **(2) Recyclable**

After the end of life of SG (B) series transformers, the copper wire can be recycled after stripping Nomex. Epoxy casting products are fully cured and cannot separate resin and copper wire, resulting in ineffective recovery or high recovery costs.

Nomex is a degradable material, and the scrapping method is burial or incineration, which does not pollute soil or air. The cost of incineration or burial of epoxy resin is very high in relative terms, resulting in significant pollution to air and soil.
- + **(3) Low noise**

The SG (B) transformer product adopts VPI vacuum dip painting method, the iron core is made of silicon steel sheet with high magnetic conductivity, and the silicon rubber plate is used between the coil and the structural parts for buffering and sound damping, so the noise is far below the national standard. At the same time, SG (B) series transformer products can be operated without fan to further reduce the noise sources.

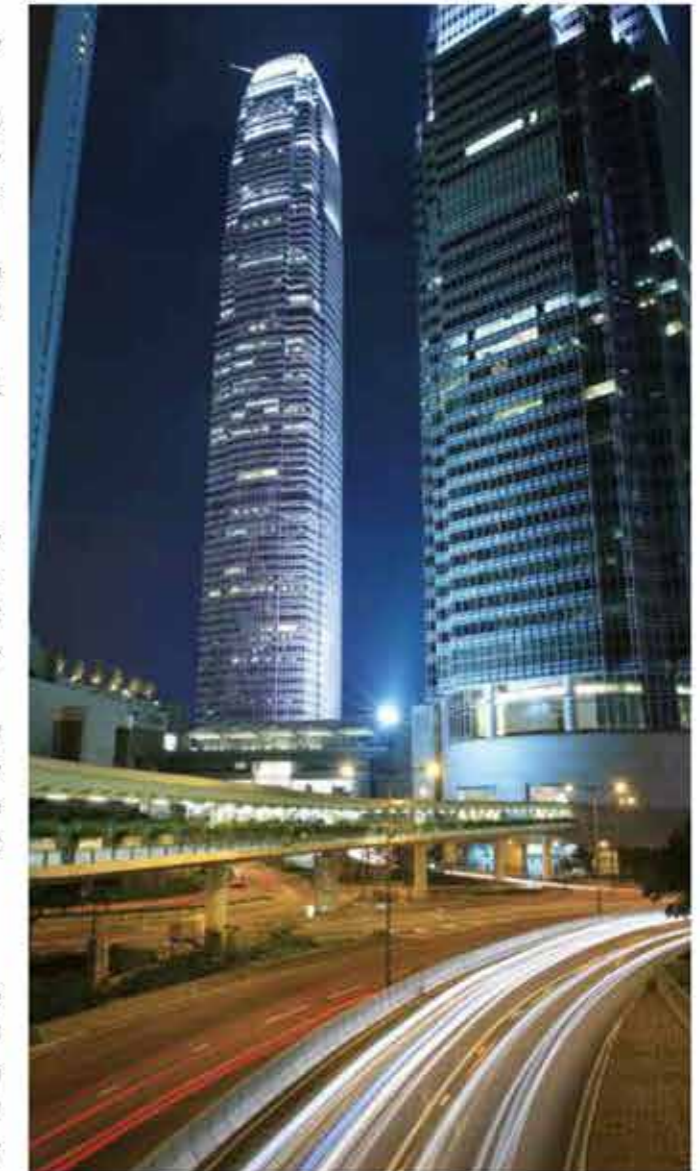

Solution: Protection Solution

Meet the Three Special Tests according to European standard HD464:

+ F1 Fire Resistance Test

SG (B) series dry-type transformers with non encapsulated structure of CEEG passed this test in Shenyang National Transformer Quality Supervision and Inspection Center, and it is the first manufacturer of VPI dry-type transformers in China to pass this test.

Fire resistance test: the transformer prototype is burned in a specific environment, and the smoke transparency, calorific value and toxic gas of the product are measured after the specified time.

The standard stipulates that the transparency of smoke shall be $\geq 20\%$ after 28 minutes and shall not contain toxic gas. The test results of SG (b) series products are as follows: the transparency of smoke after 28 minutes is $> 92.5\%$, and there is no toxic gas. The test results are in line with and superior to F1 standard, and have obtained F1 certificate.



Nearly 1/10 of the weight lost

4.6KG lost

Test Items	Standard	VPI	Cast Resin
Maximum temperature rise of exhaust port measuring section (k)	≤ 420	82	215
Temperature rise of exhaust port measuring section 45 min after the start of test (k)	≤ 140	25	107
Temperature change trend of exhaust port measuring section after 45min	Dedined	Dedined	Dedined
Temperature rise of exhaust port measuring section 60 min after the start of test (k)	≤ 80	12	69
Average transmittance of smoke exhaust duct measuring section 20 ~ 60min after the start of test (%)	≥ 20	92.5	63

Therefore, SG (G) series VPI Transformers are suitable for the following places and industries:

- + A. Shopping malls, residential areas, schools, hospitals, entertainment places and other places with high population density and strict safety requirements
Most of the victims in the fire died of smoke and toxic gas. SG (B) series VPI transformers do not contain halogen and combustible resin, and do not release toxic gas even at a high temperature of $750\text{ }^{\circ}\text{C}$. The visibility of combustion smoke is greater than 92% , which does not affect the line of sight and is easy to escape.
- + B. Electricity consumption places with high energy consumption, high load, easy overload and uneven load
Because SG (B) series VPI transformers have strong overload operation capacity, they are very suitable for places requiring high reliability and stability of equipment such as metallurgy, petrochemical and energy industry.
- + C. Coal mines, nuclear power plants, cement plants and other places with harsh environments, radioactive hazards or dust problem.
The separated disc structure is not easy to cause dust

+ Class E2 Environmental Test

Level E2 Test: including condensation test and penetration test, which is to test the ability of the transformer to adapt to various harsh environments such as condensation, salt fog and humidity.

The condensation test is to place the sample in the salt spray test box, maintain the relative humidity of $95\% \sim 98\%$, apply 1.1 times the rated voltage to the low voltage for 5 minutes after atomization treatment for 6 hours, and there is no discharge;

The penetration test is to place the sample in the high and low temperature damp heat test chamber, keep the temperature at $50\text{ }^{\circ}\text{C}$, keep the relative humidity at 90% , and place it for 144 hours, and pass the retest of withstand voltage, induction and partial discharge.

+ Class C2 Climate Test

Class C2 Climate Test: it is to test the ability of the transformer to adapt to various climates and withstand thermal shock, that is, to test whether the transformer can be stored, transported and directly put into operation under load at $-5\text{ }^{\circ}\text{C}$, $-25\text{ }^{\circ}\text{C}$ or even $-45\text{ }^{\circ}\text{C}$.

SG (B) series products produced by our company have passed the C2 ($-25\text{ }^{\circ}\text{C}$) climate test specified in the IEC standard. In order to further assess the low-temperature resistance and thermal shock resistance of SG (B) series products, the ultra-low temperature test and thermal shock test at $-45\text{ }^{\circ}\text{C}$ are also tested: place the sample in the high and low-temperature test chamber, gradually reduce it to $-45\text{ }^{\circ}\text{C}$ within 8 hours and maintain it at this temperature for 12 hours, and then immediately apply twice the rated current to the sample winding for thermal shock test to make the winding temperature reach $169\text{ }^{\circ}\text{C}$. The appearance is free of crack and deformation, and has passed the retest of withstand voltage, induction and partial discharge.

accumulation, and SG (B) series VPI transformers that have been subjected to vacuum pressure impregnation process for many times are not sensitive to dust. A large number of examples in foreign countries for more than 50 years (more than 10 years for CEEG) have also proved that SG (B) series VPI transformers can operate reliably and stably without maintenance for a long time, even in coal mines, cement plants, nuclear power plants and other places with more dust and even radiation.

- + D. Places with high requirements for moisture-proof, salt spray prevention and corrosion prevention
SG (B) series VPI transformers of our company adopt the latest VPI vacuum impregnation technology, which ensures that the coil can work normally in a humid environment. At the same time, it can be produced according to the special process requirements of marine transformer. It is suitable for places with high requirements for salt spray and corrosion resistance, such as coastal areas, ports, docks and so on.

Special Purpose Transformer: Class C SG(B) Transformer

+ Class C VPI transformer in China

Dry type transformers with Class C ($220\text{ }^{\circ}\text{C}$) insulation system are widely used in the power supply system in North America. After the continuous development of dry-type transformer technology in China, all VPI dry-type transformers adopt class H ($180\text{ }^{\circ}\text{C}$) insulation system.

At present, the manufacturing technology of class H ($180\text{ }^{\circ}\text{C}$) insulated dry-type transformer in China has been mature. On this basis, it has become an inevitable trend to develop dry-type transformers with higher heat resistance grade (grade C $220\text{ }^{\circ}\text{C}$).

According to statistics, in recent years, the application proportion of VPI dry-type transformers in the market has increased year by year, and customers' requirements for the insulation grade of such products have been continuously improved, and gradually realize the performance advantages of class C insulated transformers. In the future, the market demand of class C dry-type transformers will show an upward trend.

In order to meet the needs of different users and further improve the heat resistance grade of dry-type transformers in China, CEEG and DuPont have jointly developed a new class C SG VPI dry-type transformer, which has successfully opened the North American market on the basis of wide application in China.



Super Insulation Extreme Overload

Class C SG (B) VPI transformer is a high insulation grade transformer made of class C ($220\text{ }^{\circ}\text{C}$ heat-resistant) insulation material.

+ Performance Characteristics of class C SG (B) VPI Transformer

1. Main features of class C dry type transformer

High insulation grade, strong impact resistance, strong overload capacity, stability and reliability.

2. Basic requirements for $220\text{ }^{\circ}\text{C}$ (Class C) insulation system dry-type transformer:

According to IEC 60076-11:2004, the winding temperature rise limits of transformers with different heat-resistant insulation grades are shown in the following Table:

Insulation system temperature ($^{\circ}\text{C}$)	Average winding temperature rise limit at rated current (k)
105 (A)	60
120 (E)	75
130 (B)	80
155 (F)	100
180 (H)	125
200 (N)	135
220 (C)	150

Note: it was used to call $200\text{ }^{\circ}\text{C}$ insulation system class n and $220\text{ }^{\circ}\text{C}$ insulation system class C.

- In the $220\text{ }^{\circ}\text{C}$ insulation system, when the transformer is under rated operation, the winding temperature rise is 150 k and the hot spot temperature is $210\text{ }^{\circ}\text{C}$. We must meet this basic requirement in the design of transformer insulation system, including the selection of insulation materials, the determination of winding structure, the coordination of dimensions between components and reasonable process measures. In particular, some insulation auxiliary materials must also meet the requirements of this insulation system. The main insulation material shall meet the requirements of $220\text{ }^{\circ}\text{C}$ insulation system temperature and American (UL) certification. (for example, the brace, insulating cylinder and cushion block of class C transformer must also meet the above requirements to be a real class C transformer)

Special Purpose Transformer: Class C SG(B) Transformer

+ Advantages of CEEG class C SG (B) VPI transformer

1. The new class C SG (B) transformer of CEEG is different from class C transformers produced by other manufacturers in the industry. Class C transformers of some manufacturers in the industry only use class C materials for the main insulation, and the auxiliary insulation does not meet the class C requirements. Strictly speaking, they cannot be called class C transformers, while class C transformers of CEEG are class C transformers in the real sense.
 2. In China, the first transformer with insulation system up to class C and obtaining Canada CSA certification was designed and manufactured by CEEG;
 3. The energy consumption efficiency of the VPI transformer reaches 99.26%, 8-15 percentage points higher than that of general products;
 4. The enclosure meets the requirements of AWS certification (American Electrotechnical Association certification), Its load-bearing, heat dissipation and rainproof performance meet NEMA3R standard (requirements for outdoor enclosure in North America);
 5. References of class C transformer of CEEG
- Our company has obtained a large number of orders for class C transformers from Rio Tinto, one of the three major iron ore giants in the world. The maximum capacity of a single transformer reaches 5000KVA, and the products fully meet the requirements of CSA standard.



+ Main application fields

It is suitable for occasions requiring high operation safety and stability, such as mining industry, metallurgy industry, data center, nuclear power field, etc.

+ Qualification

1. Transformer insulation system meets UL certification (authorized by DuPont);
2. The enclosure complies with AWS and NEMA3R standards;
3. The whole set of products has passed CSA certification.



Special Purpose Transformer: "Three Prevention" Transformer

The "Three Prevention" transformer is a dry-type transformer adopting our marine transformer protection process. Relying on its "Three Prevention" advantages, this kind of transformer is especially suitable for humid, dusty and corrosive environments, such as coastal areas, inland rainy areas, dusty environments and acid-base corrosive environments (such as chemical plants).

+ Performance characteristics of "Three Prevention" dry-type transformer:

1. Moistureproof
The coil adopts VPI vacuum paint dipping process. After the transformer is assembled, it adopts overall paint dipping. After assembly, the whole transformer apart from the conductive parts is sprayed with electronic three-prevention paint to improve its protection performance and further increase its moisture-proof performance.
2. Dustproof
The transformer adopts multi-layer Nomex ® Paper insulation treatment, insensitive to dust.
3. Salt fog prevention
The surface of copper conductive parts and steel fasteners is plated or hot-dip galvanized, which has good anti-corrosion performance.

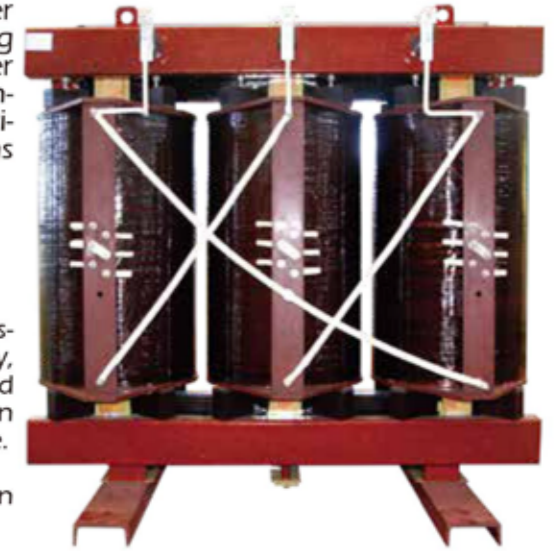

Moistureproof
Dustproof
Salt-fogproof

+ Transformer "Three Prevention" process

Our company has strong manufacturing strength of marine transformer and offshore platform transformer. It not only has well-known experts and technicians in the industry, but also is equipped with first-class process equipment and inspection equipment, and has a large number of marine transformer references. The process, equipment and technology provide a more reliable operation guarantee for the products. The marine and offshore platform transformers of our company have undergone three prevention treatments, mainly nickel plating on the surface of copper conductive parts, plating or hot galvanizing on the surface of steel fasteners, or stainless steel materials; The coil is epoxy cast or VPI vacuum impregnated; Epoxy resin paint is applied on the surface of iron core; The active part of small capacity transformer applies overall paint dipping; After assembly, the whole transformer apart from the conductive parts is sprayed with electronic three-prevention paint.

+ Application places

1. Ambient temperature: - 25 °C ~ 45 °C
2. Relative humidity ≤ 95%
3. Vibration and impact caused by working in transformer installation site
4. Swing angle ≤ 22.5 °, inclination angle ≤ 15 °
5. Affected by condensation, oil mist, salt mist and mold, it is especially suitable for humid, dusty and corrosive environments, such as coastal areas, mines, chemical fields, etc.

+ Ship Inspection Certificate



+ AFWF Transformer (Water-cooled transformer) Market

At present, the water-cooled transformer of marine propulsion system mainly uses foreign equipment for ships at home and abroad. CEEG is the first manufacturer of power propulsion water-cooled transformer in China and has many key achievements at present.



Marine water cooling propulsion system equipment

+ Development history of CEEG marine transformer

The trial production of marine transformer began in 2006 and entered the market;

In 2007, marine and offshore platform transformers passed the appraisal meeting of new products entrusted by Jiangsu Economic and Trade Commission and organized by Zhenjiang Economic and Trade Commission. The experts agreed that the products developed by our company have the characteristics of strong overload capacity, low loss, low noise, small volume, lightweight and convenient installation, and their main performance indicators have reached the domestic leading level;

In 2008, CEEG began to develop 12 pulse and 24 pulse rectifier transformers and entered the market;

The research and development of marine water-cooled transformers began in 2009, and the first batch of 8 1600KVA orders were obtained in 2010.

+ Performance characteristics of water-cooled transformer

1. Main features:

DuPont insulation system, "Three Prevention" process treatment, VPI vacuum impregnation treatment, electronic three prevention paint spraying process, etc.

2. Applicable environmental conditions:

(1) ambient temperature: maximum temperature: + 40 °C, minimum temperature: - 30 °C, maximum daily average temperature: + 20 °C, maximum annual average temperature: + 30 °C

(2) Altitude: ≤ 1000m (3) the maximum relative humidity of air (air temperature + 25 °C) shall not exceed 95%

+ Ship Inspection Certificate



Top ten well-known brands in China's electrical industry



National Innovative Enterprise



National contract abiding and trustworthy enterprise



10 billion scale enterprises in Jiangsu Province



Demonstration company of integration of informatization and industrialization in Jiangsu Province



Jiangsu Quality Management Excellence Award



Top 500 private enterprises in China



National customer satisfaction products



Nanjing Mayor Quality Award



Top 500 Asian brands



China brand annual award



China Energy Group top 500

IEC726-11 International Electrotechnical Commission Standard - dry type power transformer
 GB 1094.11-2007 dry type power transformers
 GB/T 10228-2015 technical parameters and requirements for dry type power transformers
 GB/T 17211-1998 load guide for dry type power transformers

GB 4208-1993 degrees of protection provided by enclosures (IP code)
 JB/T 10088-2004 sound level of 6-500kv transformer
 JB/T 56009-1998 product quality grading of dry type power transformers
 JB/T 501-1991 guide for power transformer test



序号	检验项目	检验依据	检验结果	备注
1	外观检查	GB 1094.11-2007	合格	
2	绕组直流电阻	GB 1094.11-2007	合格	
3	空载损耗	GB 1094.11-2007	合格	
4	短路损耗	GB 1094.11-2007	合格	
5	短路阻抗	GB 1094.11-2007	合格	
6	空载电流	GB 1094.11-2007	合格	
7	短路电压	GB 1094.11-2007	合格	
8	负载损耗	GB 1094.11-2007	合格	
9	负载电流	GB 1094.11-2007	合格	
10	负载电压	GB 1094.11-2007	合格	
11	负载损耗	GB 1094.11-2007	合格	
12	负载电流	GB 1094.11-2007	合格	
13	负载电压	GB 1094.11-2007	合格	
14	负载损耗	GB 1094.11-2007	合格	
15	负载电流	GB 1094.11-2007	合格	
16	负载电压	GB 1094.11-2007	合格	
17	负载损耗	GB 1094.11-2007	合格	
18	负载电流	GB 1094.11-2007	合格	
19	负载电压	GB 1094.11-2007	合格	
20	负载损耗	GB 1094.11-2007	合格	
21	负载电流	GB 1094.11-2007	合格	
22	负载电压	GB 1094.11-2007	合格	
23	负载损耗	GB 1094.11-2007	合格	
24	负载电流	GB 1094.11-2007	合格	
25	负载电压	GB 1094.11-2007	合格	



ISO 19001



ISO 45001



ISO 14001

Product Family



01	02	03
04	05	06
07	08	09

- 1. Amorphous Metal Transformer
- 4. 220kV Power Transformer
- 7. 110kV Power Transformer

- 2. VPI Transformer
- 5. 220kV Traction Transformer
- 8. 35kV Power Transformer

- 3. Cast Resin Transformer
- 6. 110kV Traction Transformer
- 9. 110kV Mobile Transformer

11	12	13
14	15	16
17	18	19

- 1. Mining Flame-proof Substation
- 4. Ocean Platform Transformer
- 7. Integrated PV Step-up Transformer
- 2. Rectifier Transformer
- 5. Marine Transformer
- 8. Substation

- 3. Harmonic Mitigating Transformer
- 6. AFWF Transformer
- 9. Substation